



PDX-057T-D5A / PDX-057T-D5A-512
PDX-057T-D8A / PDX-057T-D8A-512

DM&P Vortex86DX Panel PC
with 5.7" VGA TFT LCD

User's Manual

(Revision 1.2A)

● Copyright

The information in this manual is subject to change without notice for continuous improvement in the product. All rights are reserved. The manufacturer assumes no responsibility for any inaccuracies that may be contained in this document. And makes no commitment to update or to keep current the information contained in this manual.

No part of this manual may be reproduced, copied, translated or transmitted, in whole or in part, in any form or by any means without the prior written permission of the ICOP Technology Inc.

©Copyright 2011 ICOP Technology Inc.
Manual No. IUMPDX057-01 Ver.1.2A ● Feb, 2012

● Trademarks Acknowledgment

Vortex86DX™ is the registered trademark of ICOP Technology Inc. Other brand names or product names appearing in this document are the properties and registered trademarks of their respective owners. All names mentioned herewith are served for identification purpose only.

● Safety Information

- ◆ Read these Safety instructions carefully.
- ◆ Make sure the voltage of the power source is correct before connecting the equipment to the power outlet.
- ◆ Do not expose your Panel PC to rain or moisture, in order to prevent shock and fire hazard.
- ◆ Keep PDX-057T away from humidity.
- ◆ Do not open the cabinet to avoid electrical shock. Refer to your nearest dealer for qualified personnel servicing.
- ◆ Never touch un-insulated terminals or wire unless your power adaptor is disconnected.
- ◆ Locate your Panel PC as close as possible to the socket outline for easy access and to avoid force caused by entangling of your arms with surrounding cables from the Panel PC.
- ◆ USB connectors are not supplied with Limited Power Sources.
- ◆ If the equipment is not used for a long time, disconnect it from the power source to avoid damage by transient overvoltage.

DO NOT ATTEMPT TO OPEN OR TO DISASSEMBLE THE CHASSIS (ENCASING) OF THIS PRODUCT. PLEASE CONTACT YOUR DEALER FOR SERVICING FROM QUALIFIED TECHNICIAN.

Table of Contents

Table of Contents.....	iv
Chapter 1 General Information.....	1
1.1 Product Description.....	1
1.2 Product Specifications.....	2
1.3 Inspection standard for TFT-LCD Panel.....	4
1.4 Product Dimension.....	7
1.5 Ordering Information.....	8
1.6 Packing List.....	8
Chapter 2 System Installation.....	9
2.1 CPU Board Outline.....	9
2.2 Connector Summary.....	11
2.3 Connector Pin Assignments.....	12
2.4 External I/O Overview.....	15
2.5 External I/O Pin Assignment.....	16
2.6 System Mapping.....	18
2.7 Watchdog Timver.....	21
Chapter 3 Driver Installation.....	22
3.1 PDX-057T Development Note.....	23
3.2 BIOS Defaul Setting.....	26
Warranty.....	27

This page is blank

Chapter 1

General Information

1.1 Product Description

PDX-057T is an ultra compact platform for the present demanding embedded and productive applications. It has new Vortex86DX SoC CPU which consumes only minimum power requirement when running at 1GHz, and DDR2 memory provides faster data transfer rate. By using 5.7" TFT LCD, PDX-057T becomes the perfect choice for a limited budget. In addition, the integrated 10/100M Ethernet port supplies the communication capability which makes PDX-057T can be more widely used when running with DOS, Linux, Windows CE, and Windows XP environment to become the perfect solution for system integration.

- 5.7" VGA TFT LCD
- 4-Wire Resistive Touch Panel
- DM&P Vortex86DX SoC 1GHz
- 256/512MB DDR2 system memory
- AMI BIOS
- 2 watchdog timer
- Compact Flash Type I/II / Micro SD
- 10/100Mbps Ethernet
- 2 USB 2.0 (host)
- 1 RS-232/485/422 ports
- Mini-PCI Socket (Wi-Fi Optional)
- Audio Out
- Single voltage +5V DC(5A Version)
- Multi voltage +8~+35V DC(8A Version)
- Fanless Design
- Operating temperature range of -20°C to +60°

1.2 Product Specification

CPU Board Specifications	
CPU	DM&P Vortex86DX 1GHz
Cache	L1:16KB I-Cache, 16KB D-Cache L2: 128KB Cache
BIOS	AMI BIOS
Memory	256/512MB DDR2 onboard
Watchdog Timer	Software programmable from 30.5u to 512 seconds x 2 sets
LAN	Integrated 10/100M Ethernet
Audio	CM119 Line-Out
Internal Drives	Compact Flash Type I/II slot Micro SD slot
I/O	RS-232/422/485 x 1 USB ports (Ver2.0) x 2 RJ-45 Port x 1
Expansion Slot	Mini-PCI socket x 1 (Internal)
Mechanical & Environment	
Power Requirement	Single Voltage +5VDC (5A) Multi Voltage +8~+35VDC (8A)
Power Consumption	1.3A@5VDC
Operating Temperature	-20 ~ +60 °C (-4 ~ +140 °F)
Storage Temperature	-30 ~ +70 °C (-22 ~ +158 °F)
Operating Humidity	0% ~ 90% relative humidity, non-condensing
Dimensions	152 x 112 x 33mm (5.98 x 4.41 x 1.3 inches)
Weight	374g
Certification	CE, FCC, VCCI, Vibration

LCD Specifications	
Display Type	5.7" TFT LCD
Backlight Unit	LED
Display Resolution	640(W) x 480(H)
Brightness (cd/m ²)	500 nits
Contrast Ratio	300:1
Display Color	262,144
Dot Pitch (mm)	0.06 x 0.18
Viewing Angle	Vertical 100°, Horizontal 140°
Backlight Lifetime	25,000 hrs
Touchscreen	
Type	Analog Resistive
Resolution	Continuous
Transmittance	80%
Controller	USB interface
Software Driver	Linux/WinCE/WinXP
Durability	1 million

1.3 Inspection standard for TFT-LCD Panel

DEFECT TYPE			LIMIT				Note		
VISUAL DEFECT	INTERNAL	SPOT	$\varphi < 0.15\text{mm}$		Ignore		Note1		
			$0.15\text{mm} \leq \varphi \leq 0.5\text{mm}$		$N \leq 4$				
			$0.5\text{mm} < \varphi$		$N=0$				
		FIBER	$0.03\text{mm} < W \leq 0.1\text{mm}, L \leq 5\text{mm}$		$N \leq 3$		Note1		
			$1.0\text{mm} < W, 1.5\text{mm} < L$		$N=0$				
		POLARIZER BUBBLE	$\varphi < 0.15\text{mm}$		Ignore		Note1		
	$0.15\text{mm} \leq \varphi \leq 0.5\text{mm}$		$N \leq 2$						
	$0.5\text{mm} < \varphi$		$N=0$						
	Mura	It' OK if mura is slight visible through 6%ND filter							
ELECTRICAL DEFECT	BRIGHT DOT		A Grade			B Grade			
			C Area	O Area	Total	C Area	O Area	Total	Note3
			$N \leq 0$	$N \leq 2$	$N \leq 2$	$N \leq 2$	$N \leq 3$	$N \leq 5$	Note2
	DARK DOT		$N \leq 2$	$N \leq 3$	$N \leq 3$	$N \leq 3$	$N \leq 5$	$N \leq 8$	
	TOTAL DOT		$N \leq 4$			$N \leq 5$	$N \leq 6$	$N \leq 8$	Note2
	TWO ADJACENT DOT		$N \leq 0$	$N \leq 1$ pair	$N \leq 1$ pair	$N \leq 1$ pair	$N \leq 1$ pair	$N \leq 1$ pair	Note4
	THREE OR MORE ADJACENT DOT		NOT ALLOWED						
	LINE DEFECT		NOT ALLOWED						

(1) One pixel consists of 3 sub-pixels, including R,G, and B dot.(Sub-pixel = Dot)

(2) LITTLE BRIGHT DOT ACCEPTITABLE UNDER 6 % ND-Filter

(3) If require G0 grand (Total dot $N \leq 0$), please contact region sales.

[Note1] W : Width[mm], L : Length[mm], N : Number, ϕ : Average Diameter

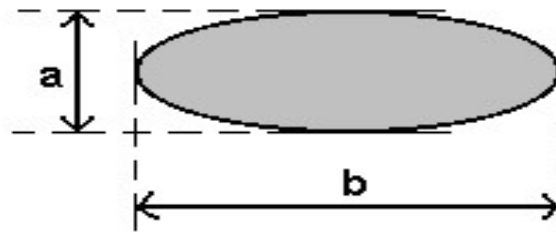

$$\phi = (a + b) / 2$$

1. (White, black) Spot
2. Polarizer Bubble

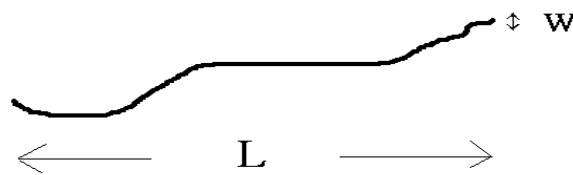

1. fiber

[Note2] Bright dot is defined through 6% transmission ND Filter as following.

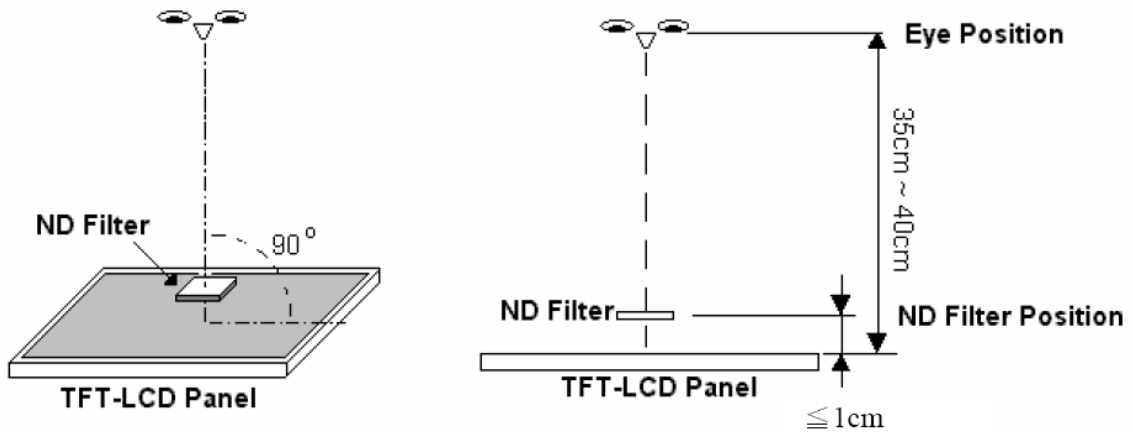

[Note3]

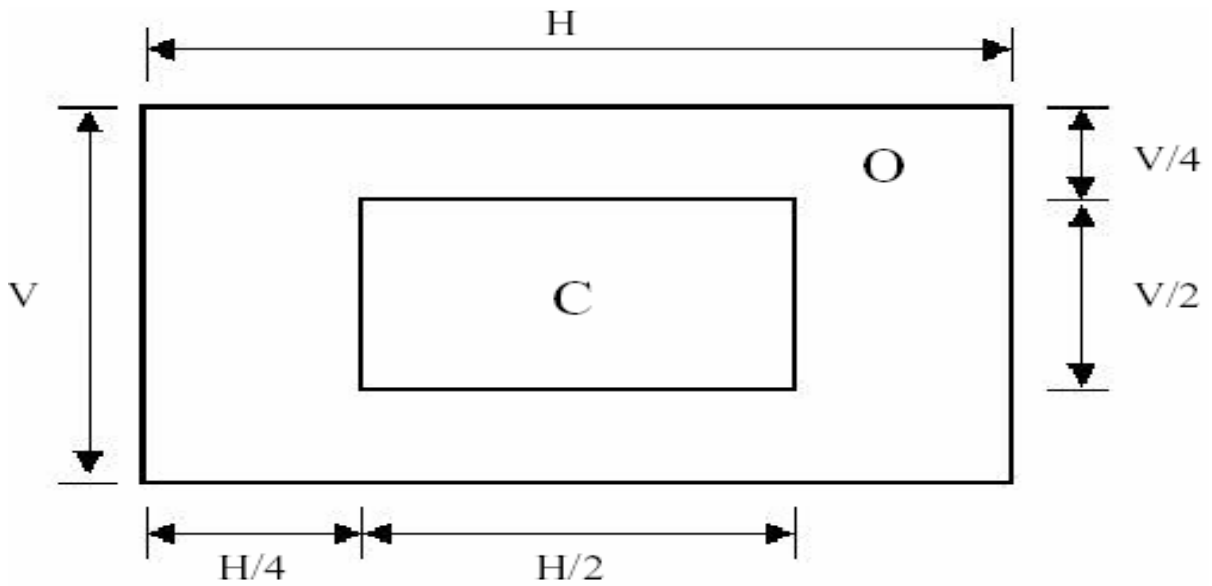

C Area: Center of display area

C Area: Outer of display area

[Note4]

Judge defect dot and adjacent dot as following. Allow below (as A, B, C and D status) adjacent defect dots, including bright and dart adjacent dot. And they will be counted 2 defect dots in total quantity.

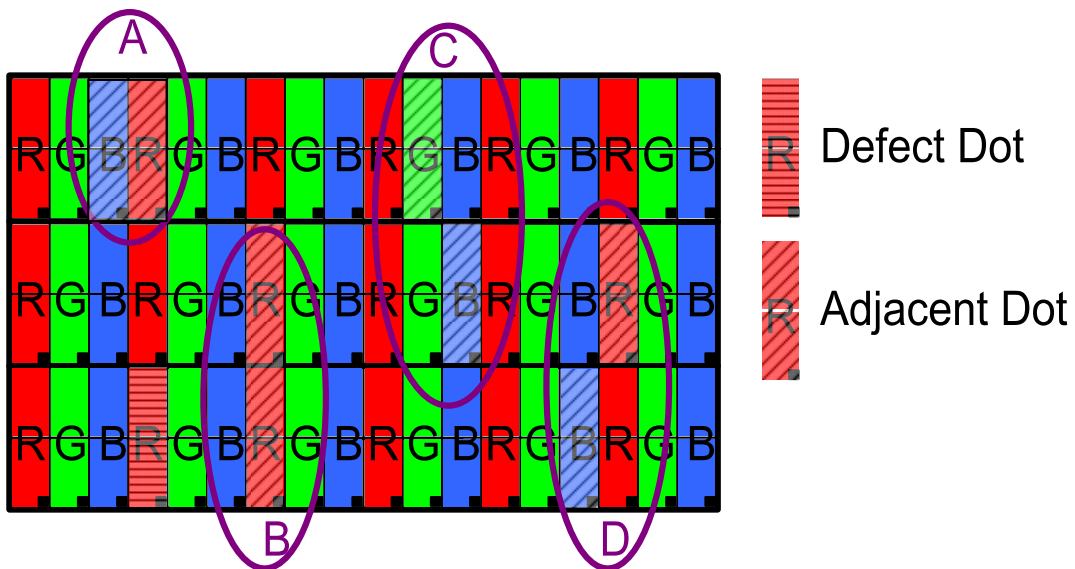

(1) The defects that are not defined above and considered to be problem shall be reviewed and discussed by both parties.

(2) Defects on the Black Matrix, out of Display area, are not considered as a defect or counted.

1.4 Product Dimension

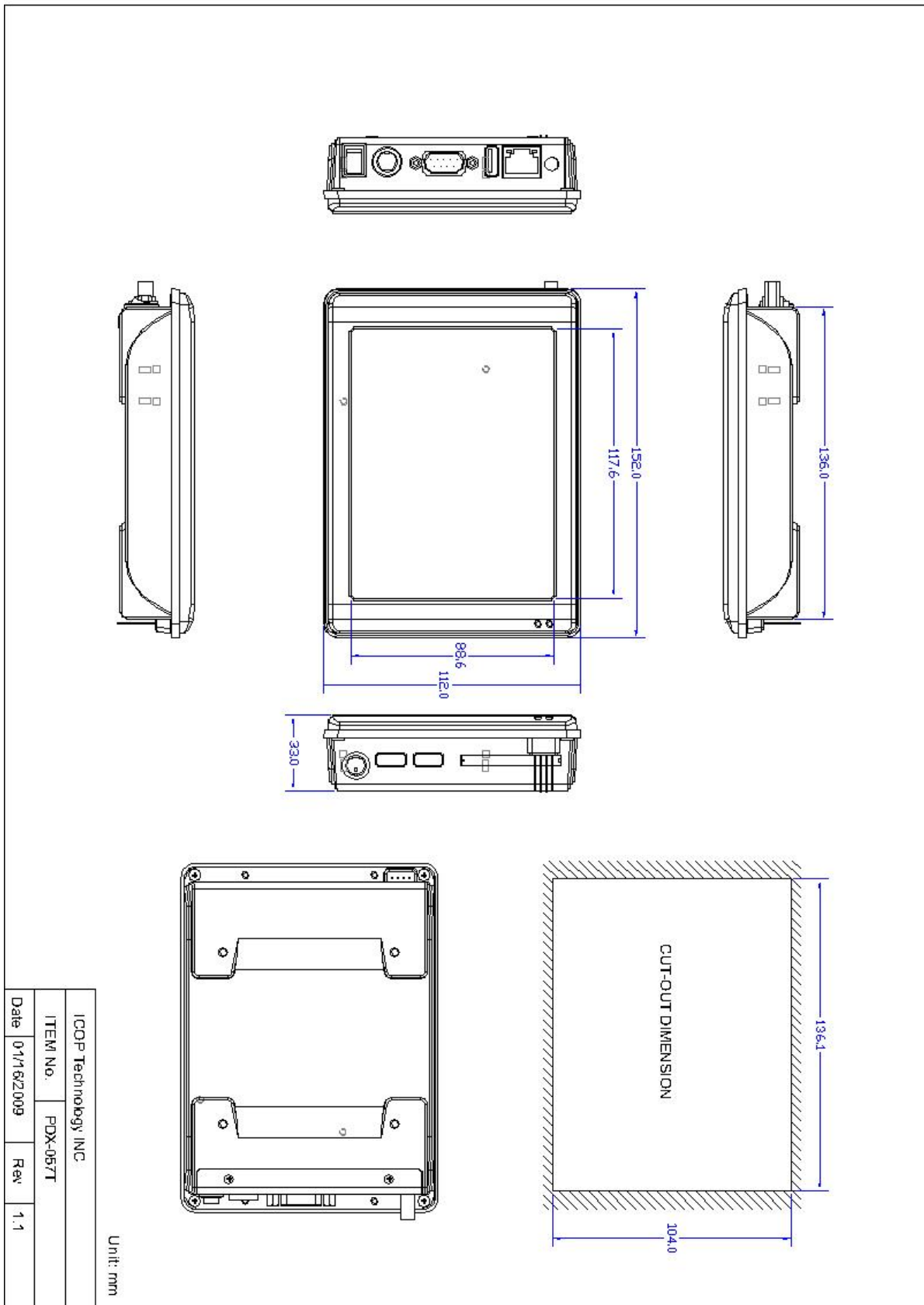

1.5 Ordering Information

Part Number	Description
PDX-057T-D5A-512	5.7" Panel PC w/512MB DDR2/2USB/Line-Out/LAN/COM/CF/MicroSD/Power Adapter
PDX-057T-D8A-512	5.7" Panel PC w/512MB DDR2/2USB/Line-Out/LAN/COM/CF/MicroSD/8-35 DC support
PDX-057T-D5A	5.7" Panel PC w/256MB DDR2/2USB/Line-Out/LAN/COM/CF/MicroSD/Power Adapter
PDX-057T-D8A	5.7" Panel PC w/256MB DDR2/2USB/Line-Out/LAN/COM/CF/MicroSD/8-35VDC support

1.6 Packing List

Part Number	Package
PDX-057T-D5A-512	<ul style="list-style-type: none"> ◆ PDX-057T-D5A-512 ◆ Power-20W-3PIN
PDX-057T-D8A-512	<ul style="list-style-type: none"> ◆ PDX-057T-D8A-512
PDX-057T-D5A	<ul style="list-style-type: none"> ◆ PDX-057T-D5A ◆ Power-20W-3PIN
PDX-057T-D8A	<ul style="list-style-type: none"> ◆ PDX-057T-D8A
WLAN KIT (Optional)	<ul style="list-style-type: none"> ◆ MINI-PCI-WLAN-CARD ◆ WIRELESS-ANTENNA-157 ◆ WIRELESS-CABLE-90MM

Chapter 2

System Installation

2.1 CPU Board Outline

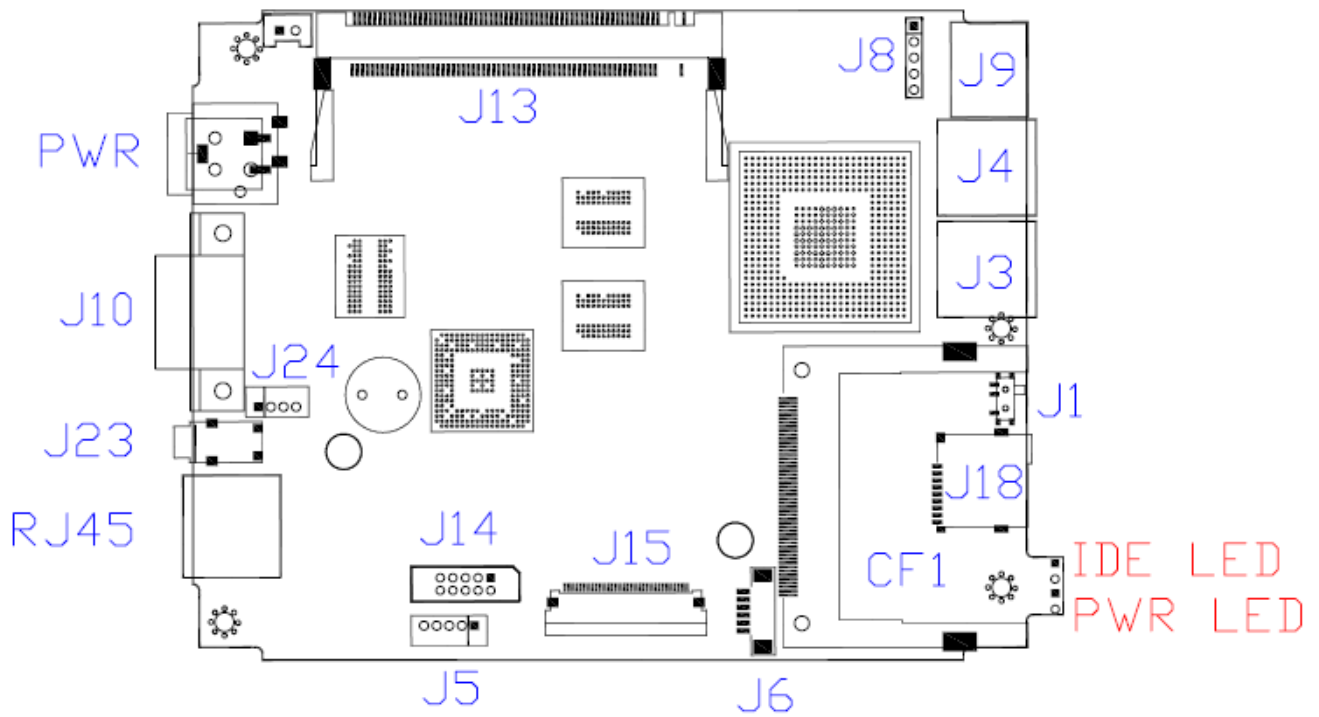

2.2 Connector Summary

Summary Table			
Nbr	Description	Type of Connections	Pin nbrs.
J1	CF Master/Slave Switch	Slide Switch	On/OFF
J3	USB	External USB Connector	6-pin
J4	USB	External USB Connector	6-pin
J5	USB (Touchscreen)	2.0mm 5-pin wafer	5-pin
J6	J-TAG	1.25mm 6-pin wafer	6-pin
J8	PS/2 Keyboard	2.54mm 5-pin box header	5-pin
J9	PS/2 Keyboard/Mouse	External Mini DIN Socket	6-pin
J10	COM2(RS232/422/485)	External D-Sub Male Connector	9-pin
J14	VGA	2.0mm 10-pin box header	10-pin
J15	LCD	0.5mm FPC/FFC Connector	40-pin
J18	Micro SD Card Socket	Micro SD socket	9-pin
J24	Audio Mic-In	2.0mm 4-pin wafer	4-pin
RJ45	Ethernet	External RJ45 Connector	8-pin
PWR	Power Connector (5A)	External Mini DIN Socket	3-pin
PWR	Power Connector (8A)	External Power Plug	2-pin
J23	Audio Line-Out	1.25mm Phone Jack	
CF1	CF Card Socket	CF Type I/II Socket	
J13	Mini-PCI Socket	Expansion Mini-PCI Socket	
J18	Micro SD Card Socket	Micro SD socket	
PWR-LED	Power Active LED (Blue)	LED-DIP	
IDE-LED	IDE Active LED (Yellow)	LED-DIP	

2.3 Connector Pin Assignments

J1: CF Master/Slave Switch

Pin #	Signal Name
On	Master
OFF	Slave

J3: USB

Pin #	Signal Name	Pin #	Signal Name
1	VCC	2	USBD2-
3	USBD2+	4	GND
5	GND	6	GND

J4: USB

Pin #	Signal Name	Pin #	Signal Name
1	VCC	2	USBD3-
3	USBD3+	4	GND
5	GND	6	GND

J5: USB (Touchscreen)

Pin #	Signal Name
1	VCC
2	USBD1-
3	USBD1+
4	GND
5	GND

J6: J-TAG

Pin #	Signal Name
1	VCC
2	GND
3	TCK
4	TDO
5	TDI
6	TMS

J8: PS/2 Keyboard

Pin #	Signal Name	Pin #	Signal Name
1	KBCLK	2	KBDAT
3	NC	4	GND
5	VCC		

J9: PS/2 Keyboard/Mouse

Pin #	Signal Name	Pin #	Signal Name
1	KBCLK	2	MSCLK
3	GND	4	KBDATA
5	MSDATA	6	VCC
7	GND	8	GND
9	GND		

J10: COM1 RS232/422/485 (Change setting by BIOS)

Pin #	Signal Name	Pin #	Signal Name
1	DCD1 / 422TX- / RS485-	2	RXD1 / 422TX+ / RS485+
3	TXD1 / 422RX+	4	DTR1 / 422RX-
5	GND	6	DSR1
7	RTS1	8	CTS1
9	RI1		

J14: VGA

Pin #	Signal Name	Pin #	Signal Name
1	R OUT	2	GND
3	G OUT	4	GND
5	B OUT	6	GND
7	HSYNC	8	GND
9	VSYNCD	10	GND

J15: LCD

Pin #	Signal Name
1	3.3V
2	3.3V

3	HSYNC
4	5V
5	5V
6	5V
7	3.3V
8	VSYNC
9	DE
10	GND
11	GND
12	GPIOB
13	B5
14	B4
15	B3
16	GND
17	B2
18	B1
19	B0
20	GND
21	G5
22	G4
23	G3
24	GND
25	G2
26	G1
27	G0
28	GND
29	R5
30	R4
31	R3
32	GND
33	R2
34	R1
35	R0
36	GND
37	GND
38	CLK
39	GND
40	L/R

J24: MIC-IN

Pin #	Signal Name
1	MICVREF
2	GND
3	GND
4	MIC-IN

PWR: Power Connector (5A)

Pin #	Signal Name
1	+5V
2	GND
3	NC
4	GND

PWR: Power Connector (8A)

Pin #	Signal Name
1	+ 8 ~ 35V
2	GND

2.4 External I/O Overview

PDX-057T-D8A / PDX-057T-D8A-512

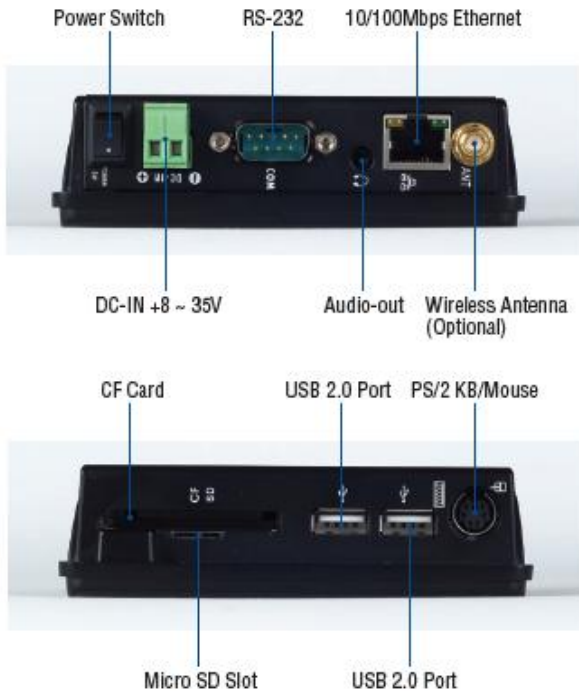

PDX-057T-D5A / PDX-057T-D5A-512

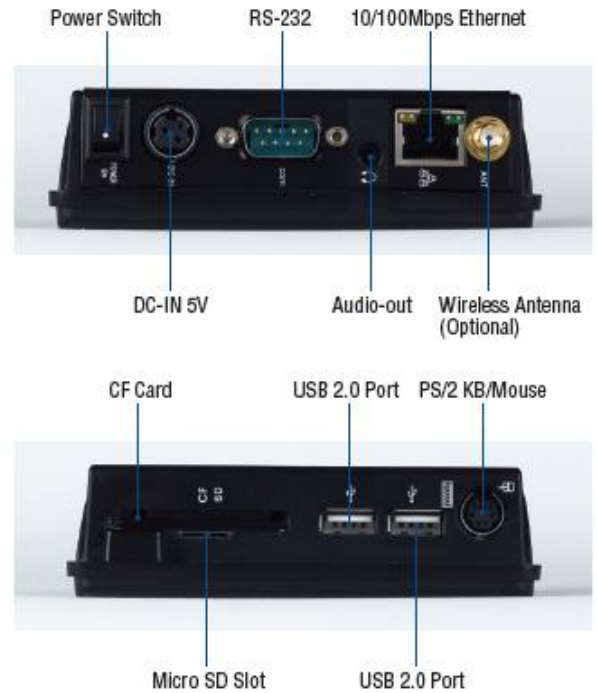

(Note1: Wireless is optional)

(Note2: COM1 RS232/422/485 is selected by BIOS setting)

2.5 External I/O Pin Assignment

Power Switch

	Pin #	Status
		ON
	o	OFF

Power Connector (5A)

	Pin #	Signal Name
	1	+5V
	2	GND
	3	NC

Power Connector (8A)

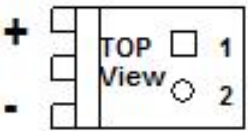
	Pin #	Signal Name
	1	+8 ~ 35V
	2	GND

J10: COM1 RS232/422/485 (Change setting by BIOS)

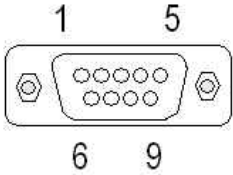
	Pin #	Signal Name	Pin #	Signal Name
	1	DCD1/422TX-/RS485-	2	RXD1/422TX+/RS485+
	3	TXD1 / 422RX+	4	DTR1 / 422RX-
	5	GND	6	DSR1
	7	RTS1	8	CTS1
	9	R11		

Audio Line-Out

	Pin #	Signal Name
	1	GND
	2	LOUTL
	3	Open Touch
	4	Open Touch
5	VREFOUT	

USB

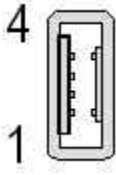
	Pin #	Signal Name
	1	VCC
	2	USB0-
	3	USB0+
	4	GND
	5	GGND
6	GGND	

RJ45

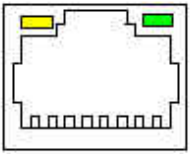
	Pin #	Signal Name	Pin #	Signal Name
	1	FTXD+	2	FTXD-
	3	FRXIN+	4	NC
	5	NC	6	FRXIN-
	7	NC	8	NC

PS/2 Keyboard/Mouse

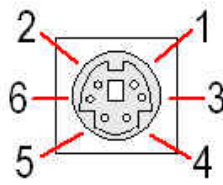
	Pin #	Signal Name
	1	KBCLK
	2	PMCLK
	3	GND
	4	KBDAT
	5	PMDAT
6	SB5V	

2.6 System Mapping

System Mapping		
Memory Mapping		
Address	Description	Usage
0000:0000-9000:FFFF	System RAM	*
A000:0000-A000:FFFF	EGA/VGA Video Memory	*
B000:0000-B000:7FFF	MDA RAM, Hercules graphics display RAM	*
B000:8000-B000:FFFF	CGA display RAM	*
C000:0000-C000:7FFF	EGA/VGA BIOS ROM	*
C000:8000-C000:FFFF	Boot ROM enable.	*
D000:0000-D700:FFFF	Expansion ROM space.	
D800:0000-DB00:FFFF	SPI FLASH Emulation Floppy A Enable	
DC00:0000-DF00:FFFF	Expansion ROM space.	
E000:0000-E000:FFFF	USB Legacy SCSI ROM space.	*
F000:0000-F000:FFFF	Motherboard BIOS	*
I/O Mapping		
I/O Address	Owner	Usage
0000h - 000Fh	DMA 8237-1	*
0010h - 0017h	COM 9	
0018h - 001Fh	Empty	
0020h - 0021h	PIC 8259-1	*
0022h - 0023h	6117D configuration port	*
0024h - 002Dh	Empty	
002Eh - 002Fh	Forward to LPC BUS	*
0030h - 003Fh	Empty	
0040h - 0043h	Timer counter 8254	*
0044h - 0047h	Empty	
0048h - 004Bh	PWM counter 8254	*
004Ch - 004Dh	Empty	
004Eh - 004Fh	Forward to LPC BUS	*
0050h - 005Fh	Empty	
0060h	Keyboard data port	*

0061h	Port B + NMI control port	*
0062h - 0063h	8051 download 4K address counter	*
0064h	Keyboard status port	*
0065h	WatchDog0 reload counter	*
0066h	8051 download 8bit data port	*
0067h	WatchDog1 reload counter	*
0068h - 006Dh	WatchDog1 control register	*
006Eh - 006Fh	Empty	
0070h - 0071h	CMOS RAM port	*
0072h - 0075h	MTBF counter	*
0076h - 0077h	Empty	
0078h - 007Ch	GPIO port 0,1,2,3,4 default setup	*
007Dh - 007Fh	Empty	
0080h - 008Fh	DMA page register	*
0090h - 0091h	Empty	
0092h	System control register	*
0093h - 0097h	Empty	
0098h - 009Ch	GPIO direction control	*
00A0h - 00A1h	PIC 8259-2	*
00A2h - 00BFh	Empty	
00C0h - 00DFh	DMA 8237-2	*
00E0h - 00FFh	Empty	
0100h - 0101h	GPCS1 default setting address	*
0170h - 0177h	IDE1 (IRQ 15)	*
01F0h - 01F7h	IDE0 (IRQ 14)	*
0220h - 0227h	COM8 Forward to LPC BUS	
0228h - 022Fh	COM7 Forward to LPC BUS	
0238h - 023Fh	COM6 Forward to LPC BUS	
0278h - 027Fh	Printer port (IRQ 7, DMA 0)	
02E8h - 02EFh	COM4 (IRQ 11)	*
02F8h - 02FFh	COM2 (IRQ 3)	*
0338h - 033Fh	COM5 Forward to LPC BUS	
0376h	IDE1 ATAPI device control write only register	*
03E8h - 03Efh	COM3 (IRQ 10)	*
03F0h - 03F7h	Floppy Disk (IRQ 6, DMA 2)	
03F6h	IDE0 ATAPI device control write only register	*
03F8h - 03FFh	COM1 (IRQ 4)	*
0480h - 048Fh	DMA High page register	*
0490h - 0499h	Instruction counter register	*
04D0h - 04D1h	8259 Edge,/ level control register	*

0CF8h - 0CFFh	PCI configuration port	*
D400h - D4FFh	on board LAN	*
FC00h - FC05h	SPI Flash BIOS control register	*
FC08h - FC0Dh	External SPI BUS control register (output pin configurable GPIO3[0-3])	*

IRQ Mapping

IRQ#	Description	Usage
IRQ0	System Timer	*
IRQ1	Keyboard Controller	*
IRQ2	Cascade for IRQ8 - 15	
IRQ3	Serial Port 2	*
IRQ4	Serial Port 1	*
IRQ5	USB	*
IRQ6	USB	*
IRQ7	USB	*
IRQ8	Real Time Clock	*
IRQ9	USB / Ethernet 10/100M LAN	*
IRQ10	Serial Port 3	*
IRQ11	Serial Port 4	*
IRQ12	Mouse	*
IRQ13	Math Coprocessor	*
IRQ14	Hard Disk Controller#1	*
IRQ15	Hard Disk Controller#2	*

DMA Mapping

DMA#	Description	Usage
DMA0		
DMA1		
DMA2	Floppy Disk Controller	
DMA3		
DMA5		
DMA6		
DMA7		

2.7 Watchdog Timer

There are two watchdog timers in PDX-057T, we also provide DOS, Linux and WinCE example for your reference. For more technical support, please visit: <http://www.dmp.com.tw/tech> or download the PDF file: <http://www.dmp.com.tw/tech/vortex86dx/>

Chapter 3

Driver Installation

VGA

The Vortex86DX processor also use external Display chip “Volari™ Z9s” which is an ultra low powered graphics chipset with total power consumption at around 1-1.5 W.

LAN

The Vortex86DX processor also integrated 10/100Mbps Ethernet controller that supports both 10/100BASE-T and allows direct connection to your 10/100Mbps Ethernet based Local Area Network for full interaction with local servers, wide area networks such as the Internet.

I/O and IRQ settings can be done by software with the supplied utility software, or it can be set for Plug and Play compatibility. The controller supports: Half / Full-Duplex Ethernet function to double channel bandwidth, auto media detection.

AUDIO

CM119 is a highly integrated single chip USB audio controller specifically for VoIP (Voice over internet protocol) application. All essential analog modules are embedded in CM119, including dual DAC and earphone driver, ADC, microphone booster, PLL, regulator, and USB transceiver. 8 GPIO pins can constitute a 24 key matrix directly support keypad control function without MCU.

Many features are programmable with jumper pins or external EEPROM. Vender can customize unique USB VID/PID to EEPROM for VoIP software authentication. Moreover, individual unique phone number for each device is possible via serial number stored in external EEPROM.

Operating system support

The PDX-057T provides the VGA and LAN drivers for Linux, Windows CE 5.0, CE 6.0, Windows XP Professional, and Windows Embedded standard (XPE). **(Linux can use with Compact Flash card only.)**

Please get the drivers from DMP official website: <http://www.dmp.com.tw/tech/vortex86dx/> .

PDX-057T also supports most of the popular Linux distributions, for more detail information, please visit DMP official website: <http://www.dmp.com.tw/tech/vortex86dx/>.

3.1. PDX-057T Development Note

<Primary /Secondary IDE: Master or Slave>

Micro SD: Primary Master

CF Slot: Secondary IDE: Master or Slave (User can use slide switch (in side of CF slot) to adjust Master or Slave

<Window CE6.0 development guide>

Windows Embedded CE 6.0 BSP, trial CE image and development notes, please visit technical website to get more information: <http://tech.icop.com.tw/>

<Linux installation note>

Please forced the IDE setting in BIOS to PIO mode before install Linux on PDX-057T as follows:

1-Go to the advanced BIOS setting and make the “Onboard IDE Operate Mode” is “Legacy Mode”

2-Go to the PCI/PnP and make the “PCI IDE BusMaster” is “Disable”

< XP professional /Home /Embedded and Windows 2000 installation note >

1-Please visit technical website to get more information: <http://tech.icop.com.tw/>

<Enhance CF to run the UDMA2/4>

1-Please select ICOP “ICF Card” to supporting UDMA 2/4 Mode.

<How to boot up from the Micro SD card>

1-Get into the BIOS setup Utility

2-Go to the Advanced

3-Choose Primary IDE Pin Select: SD card

4-Press “F10” to save configuration changes and exit setup

<Backlight On/Off through GPIO control>

Sample Code:

```

#include "stdafx.h"

unsigned char inportb(short addr)
{
    unsigned char cValue;
    __asm
    {
        mov dx, addr
        in  ax, dx
        mov cValue, al
    }

    return cValue;
}

void outpourtb(int addr, unsigned char val)
{
    __asm
    {
        push edx
        mov  edx, DWORD PTR addr
        mov  al,  BYTE PTR val
        out dx, al
        pop edx
    }
}

```

```

void BackLightON()
{
    // Set register 4AH bit1 to 0 to enable GPIOB
    outportb(0x3d4, 0x4a);
    unsigned c = inport(0x3d5) & 0xfd;
    outportb(0x3d4, 0x4a);
    outportb(0x3d5, c);
    // Set register 48H bit1
    outportb(0x3d4, 0x48);
    c = inport(0x3d5) | 0x02;
    outportb(0x3d4, 0x48);
    outportb(0x3d5, c);
}

```

```

void BackLightOFF()
{
    // Set register 4AH bit1 to 0 to enable GPIOB
    outportb(0x3d4, 0x4a);
    unsigned c = inport(0x3d5) & 0xfd;
    outportb(0x3d4, 0x4a);
    outportb(0x3d5, c);
    // Clear register 48H bit1
    outportb(0x3d4, 0x48);
    c = inport(0x3d5) & 0xfd;
    outportb(0x3d4, 0x48);
    outportb(0x3d5, c);
}

```

Note:

1-Wi-Fi module is optional: <http://www.icop.com.tw/pddetail.aspx?id=67&pid=4>

2 -PDX-057T COM1: support RS232/422/485, please contact your regional sales.

3 -PDX-057T series (CPU Speed: 1GHZ): Support Linux, Windows CE 5.0, CE 6.0, Windows XP Professional, and Windows Embedded standard (XPE). **(Linux can use with Compact Flash card only.)**

3.2. BIOS Default setting

If the system cannot be booted after BIOS changes are made, Please follow below procedures in order to restore the CMOS as default setting.

- Press "End" Key, when the power on



- Press to enter the AMI BIOS setup
- Press "F9" to Load Optimized Defaults
- Press "F10" to Save configuration changes and exit setup

Warranty

This product is warranted to be in good working order for a period of one year from the date of purchase. Should this product fail to be in good working order at any time during this period, we will, at our option, replace or repair it at no additional charge except as set forth in the following terms. This warranty does not apply to products damaged by misuse, modifications, accident or disaster. Vendor assumes no liability for any damages, lost profits, lost savings or any other incidental or consequential damage resulting from the use, misuse of, originality to use this product. Vendor will not be liable for any claim made by any other related party. Return authorization must be obtained from the vendor before returned merchandise will be accepted. Authorization can be obtained by calling or faxing the vendor and requesting a Return Merchandise Authorization (RMA) number. Returned goods should always be accompanied by a clear problem description.